



**GIOVENZANA  
INTERNATIONAL B.V.**

**H A N D L I N G   S Y S T E M**



**H A N D L I N G   S Y S T E M**

**GENERAL CATALOGUE**

**GIOVENZANA INTERNATIONAL reserves the right to modify, in order to improve their performance, all technical and functional characteristics of the products shown in the catalogue without prior notice as this information is intended for general knowledge and is not legally binding.**

# Energy and data transmission

## 28 - 30 - 41- wire rope-i beam - TR 85 Series

### Table of contents



TECHNO-LIFTING EQUIPMENT

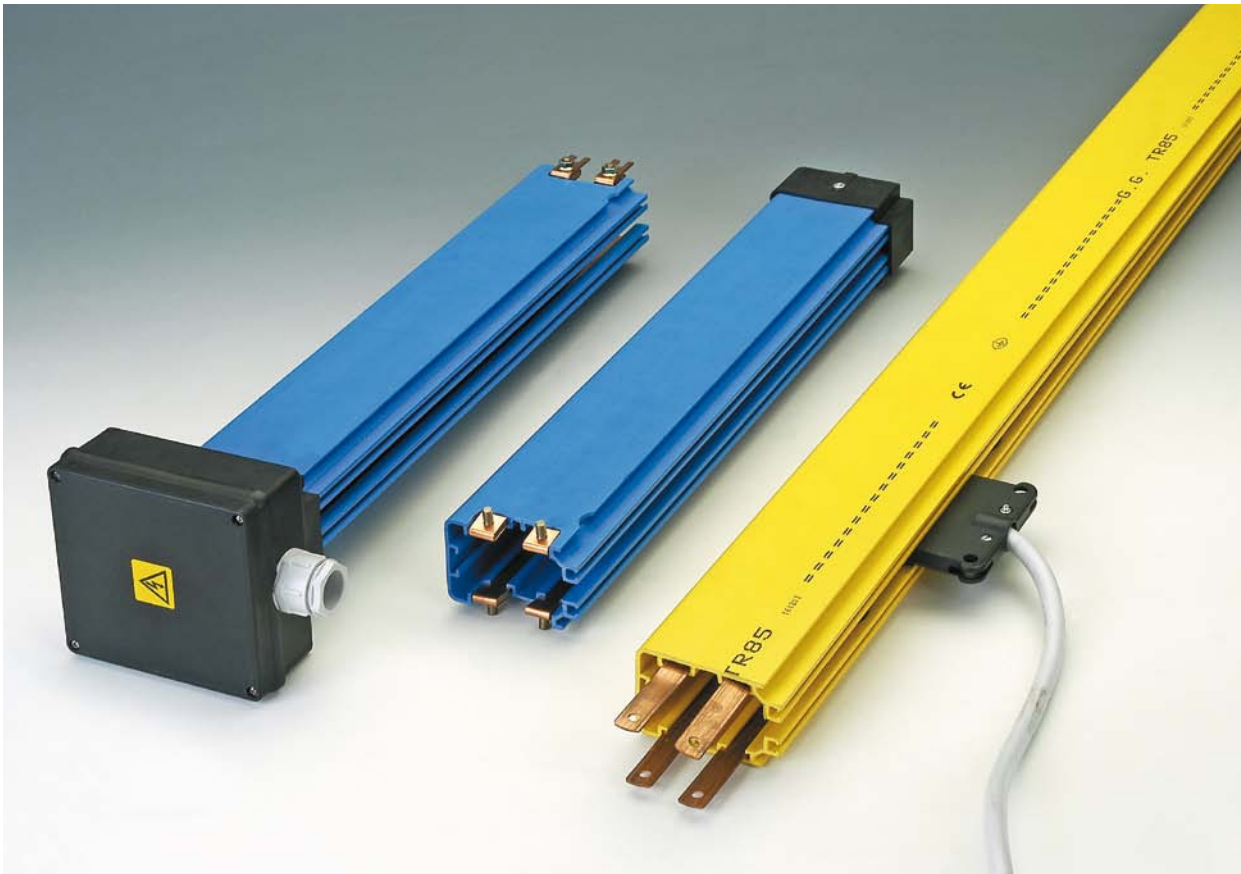

The fastoon system includes 28,30,41; Series c-rail cable trolley wire rope cable Trolleys, i-beam cable Trolley. The TR85 series conductor rail range offers both plug-in (line **A**) or continuous strip (line **B**) type system.

### TABLE OF CONTENTS





■ 28 Series fastoon system	pag. 46	■ TR85 Series Trolley system	pag. 63
■ 30 Series fastoon system	pag. 49	■ Calculation line	
■ 41 Series fastoon system	pag. 52	■ TR85 Series Trolley system	pag. 65
■ Wire rope Series $\varnothing 8$	pag. 57	■ Examples of orders	
■ Light i-beam Series	pag. 58	■ TR85 Series Trolley system	pag. 66
■ Heavy i-beam Series	pag. 59	■ TR85 Series conductor rails line <b>A</b> plug-in type	
■ 28 - 30 - 41 Series conduct rails	pag. 60	■ TR85 Series Trolley system	pag. 69
■ Example of installation		■ TR85 Series conductor rails line <b>B</b> continuous strip type	
■ TR85 Series Trolley system - Characteristic	pag. 61	■ Conductors CP and CT Series	pag. 74
■ TR85 Series Trolley system	pag. 62	■ Spare parts	pag. 76
■ Characteristics - Calculation for down-current		■ Disconnectors	

# Energy and data transmission

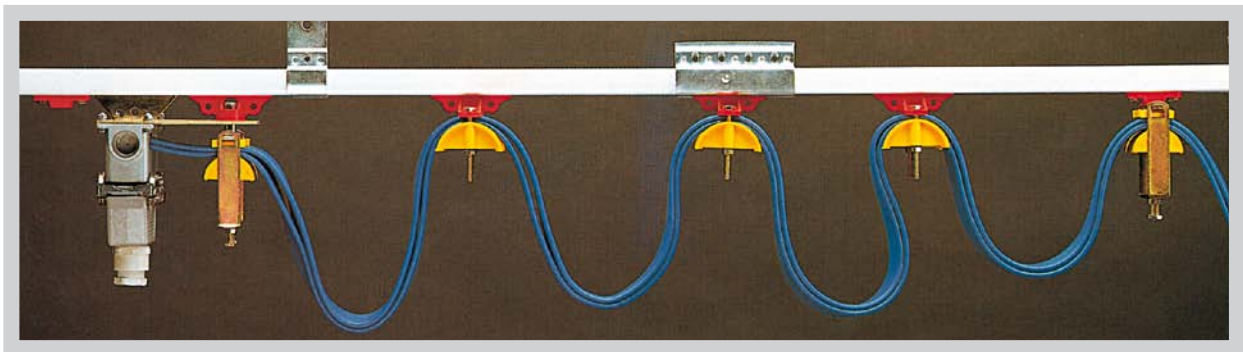
## 28 Series

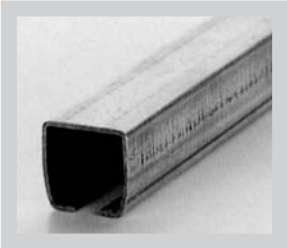
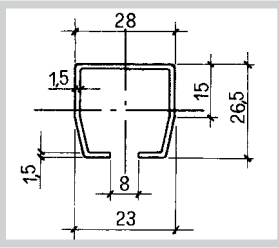
Festoon system

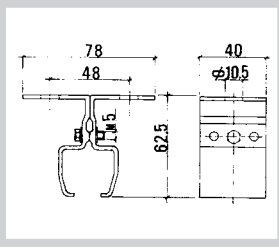
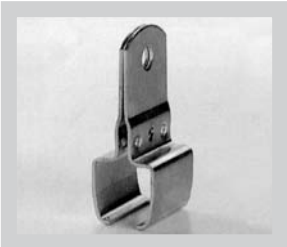
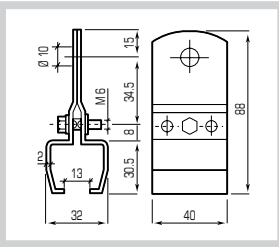

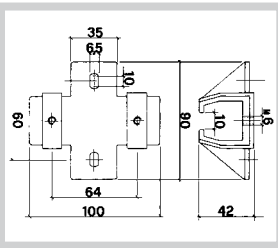





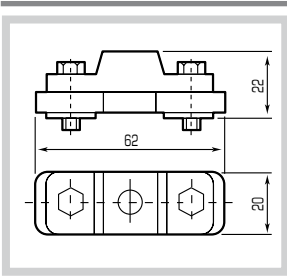

	DESCRIPTION	CODE	MIN. PACK QTY.	DIMENSIONS
	<b>C-Rail bar</b> <ul style="list-style-type: none"> <li>Material: galvanized steel</li> <li>Length: 4 mt</li> <li>Weight: 3,92 kg</li> <li>Load capacity: 100 kg/mt</li> </ul>	30603001/4	1	
	<b>Track support bracket</b> 2 Pieces Bolts is excluded <ul style="list-style-type: none"> <li>Material: galvanized steel</li> <li>Step for recommended mounting near between two bracket: 1 mt</li> </ul>	30603002	1	
	<b>Track support bracket</b> 2 Pieces Bolts is excluded <ul style="list-style-type: none"> <li>Material: galvanized steel</li> <li>Step for recommended mounting near between two bracket: 1 mt</li> </ul>	30603003	1	
	<b>Bracket connectors</b> To join c-rails and suitable for supporting the track <ul style="list-style-type: none"> <li>Material: PA 6</li> </ul>	30603004	1	

# Energy and data transmission

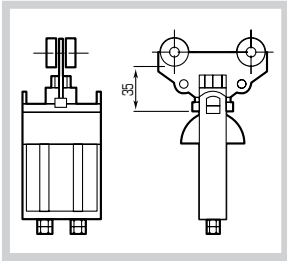
## 28 Series Festoon system

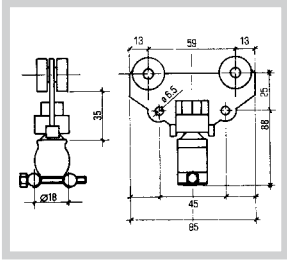

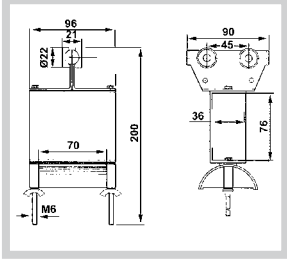

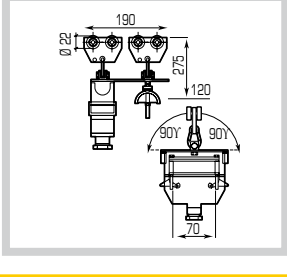



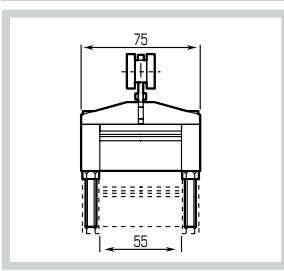

TECHNO-LIFTING EQUIPMENT

	DESCRIPTION	CODE	MIN. PACK QTY.	DIMENSIONS
	<p><b>End stop</b></p> <ul style="list-style-type: none"> <li>Material: PA 6</li> </ul>	30603005	1	
	<p><b>Flat cable trolley</b></p>	30603008	10	
	<p><b>Round cable trolley with rotating saddle</b></p> <ul style="list-style-type: none"> <li>Material: PA 6</li> <li>Type of roller: steel roller with ball. Travel speed 80mt/min</li> <li>Load capacity: 15kg</li> <li>55 mm Plastic saddle (excursion 50 mm)</li> </ul>	30603012	10	
	<p><b>Round cable trolley</b> With metal cable clip</p> <ul style="list-style-type: none"> <li>Max cable diameter: 18 mm</li> <li>Material: PA 6</li> <li>Type of roller: steel roller with ball. travel speed 80 mt/min.</li> <li>Load capacity: 15kg</li> </ul>	30603024	10	
	<p><b>Towing trolley</b></p> <ul style="list-style-type: none"> <li>Material: galvanized steel</li> <li>Type of roller: steel roller with ball. travel speed 80 mt/min.</li> <li>68 mm: Plastic saddle</li> </ul>	30603064	1	
	<p><b>Trolley with plug and safety socket connection</b> To connect the festoon system to the pendant station</p> <ul style="list-style-type: none"> <li>68 mm: Plastic saddle</li> <li>16 Poles</li> <li>24 Poles</li> </ul>	30603066 30603067	1 1	

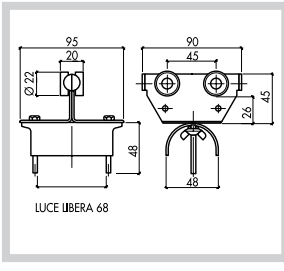
# Energy and data transmission

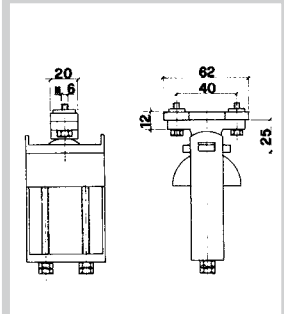
## 28 Series

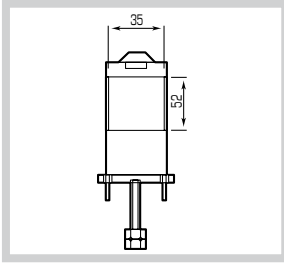
Festoon system

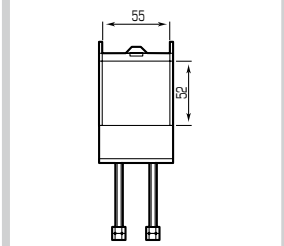
	DESCRIPTION	CODE	MIN. PACK QTY.	DIMENSIONS
	<p><b>Light Series Trolley</b> Main body, saddle and wheels in PA for a considerable noise reduction</p> <ul style="list-style-type: none"> <li>■ Type of roller: PA roller Travel speed 40 mt/min.</li> <li>■ Load capacity: 10 kg</li> <li>■ 55 mm: Plastic saddle</li> </ul>	30603035	10	
	<p><b>Steel trolley</b></p> <ul style="list-style-type: none"> <li>■ Material: galvanized steel</li> <li>■ Type of roller: steel rollers with ball bearings: travel speed 80 m/min.</li> <li>■ Load capacity: 15 kg</li> <li>■ 68 mm: Plastic saddle</li> </ul>	30603061	10	 <p>LUCE LIBERA 68</p>
	<p><b>End clamp</b></p> <ul style="list-style-type: none"> <li>■ Material: PA 6</li> <li>■ Load capacity: 15 kg</li> <li>■ 55 mm Plastic saddle Range 50 mm</li> <li>■ 68 mm Plastic saddle Range 50 mm</li> <li>■ Metal cable clip</li> </ul>	<p>30603016</p> <p>30603065</p> <p>30603018</p>	<p>1</p> <p>1</p> <p>1</p>	
	<p><b>40 mm Plastic saddle</b></p> <ul style="list-style-type: none"> <li>■ Material: PA 6 and galvanized steel</li> <li>■ Range 50 mm</li> </ul>	30603030	10	
	<p><b>55 mm Plastic saddle</b></p> <ul style="list-style-type: none"> <li>■ Material: PA 6 and galvanized steel</li> <li>■ Range 50 mm</li> </ul>	30603031	10	





# Energy and data transmission

## 30 Series Festoon system

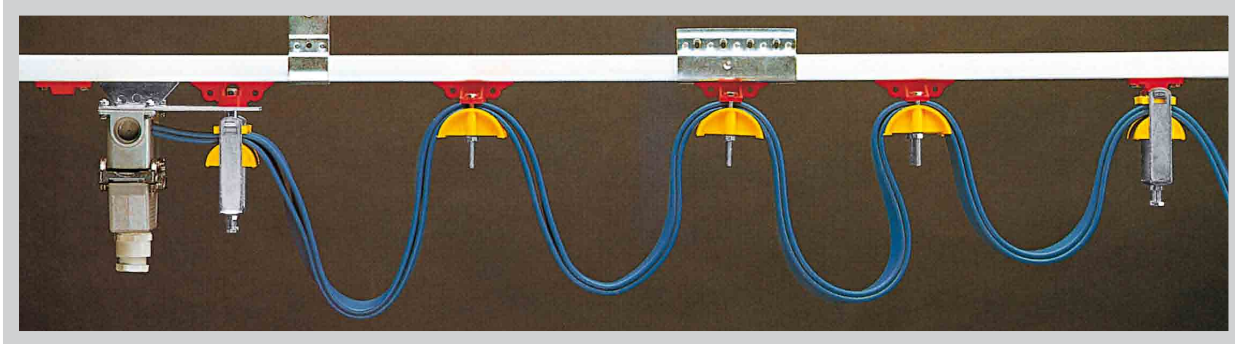

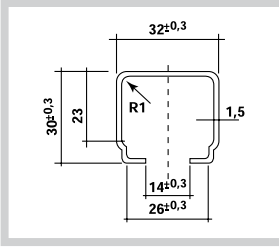
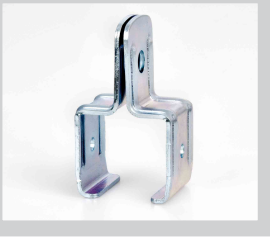
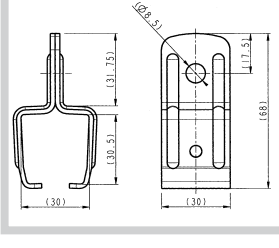
TECHNO-LIFTING EQUIPMENT

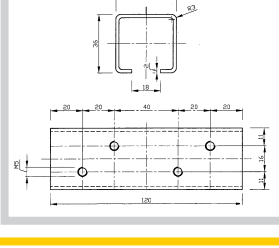

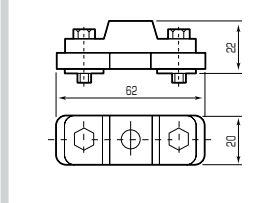



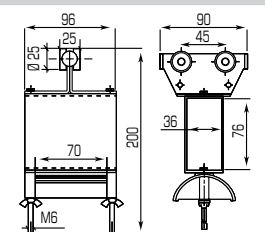

	DESCRIPTION	CODE	MIN. PACK QTY.	DIMENSIONS
	<b>C-Rail bars</b> <ul style="list-style-type: none"> <li>Material: galvanized steel</li> <li>Length: 4 mt</li> <li>Weight: 5 kg</li> <li>Load capacity: 100 kg/mt</li> </ul>	30607001	1	
	<b>Truck support bracket</b> 2 Pieces <ul style="list-style-type: none"> <li>Material: galvanized steel</li> <li>Max support spacing: 1mt</li> </ul>	30607003	1	
	<b>Truck support bracket</b> To connect a C-Rails and suitable for supporting the track ceiling fixing <ul style="list-style-type: none"> <li>Material: galvanized steel</li> </ul>	30607002	1	
	<b>End stop</b> <ul style="list-style-type: none"> <li>Material: PA 6</li> </ul>	30607005	1	

# Energy and data transmission

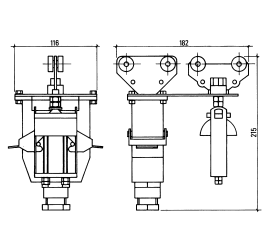
## 30 Series

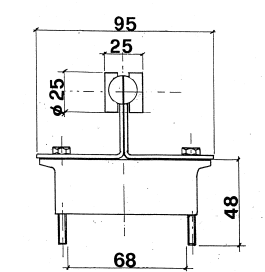
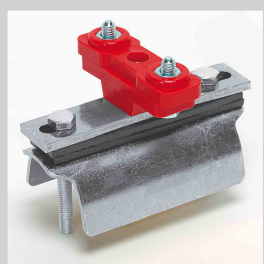
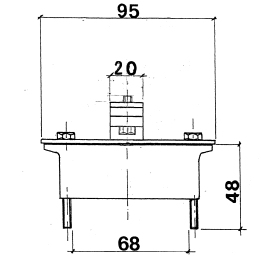
Festoon system

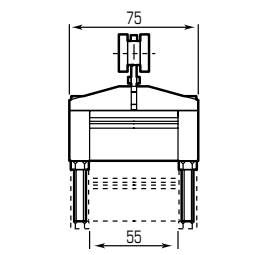
	DESCRIPTION	CODE	MIN. PACK QTY.	DIMENSIONS
	<p><b>Towing trolley</b></p> <ul style="list-style-type: none"> <li>Material: galvanized steel</li> <li>Type of roller: steel rollers with ball</li> <li>68 mm Plastic saddle</li> </ul>	<p>30607007</p>	<p>1</p>	
	<p><b>Trolley with safety plug and socket connection</b></p> <ul style="list-style-type: none"> <li>To connect the festoon system to the pendant station</li> <li>68 mm Plastic saddle</li> <li>16 Poles</li> <li>24 Poles</li> </ul>	<p>30607008 30607019</p>	<p>1 1</p>	
	<p><b>Towing trolley</b></p> <ul style="list-style-type: none"> <li>Material: galvanized steel</li> <li>Type of roller: steel rollers with ball</li> <li>68 mm Plastic saddle</li> <li>Material: galvanized steel</li> <li>Type of roller: steel rollers with wheels</li> <li>68 mm Plastic saddle</li> </ul>	<p>30607010 30607009</p>	<p>10 10</p>	
	<p><b>End clamp</b></p> <ul style="list-style-type: none"> <li>Material: PA 6 and galvanized steel</li> <li>68 mm Plastic saddle</li> </ul>	<p>30607006</p>	<p>1</p>	
	<p><b>Trolley in PA</b></p> <ul style="list-style-type: none"> <li>Material: PA</li> <li>Type of roller: PA steel rollers with ball bearings</li> <li>55 mm Plastic saddle</li> </ul>	<p>30607011</p>	<p>10</p>	





# Energy and data transmission

## 30 Series

Festoon system

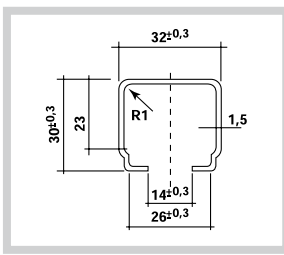

TECHNO-LIFTING EQUIPMENT

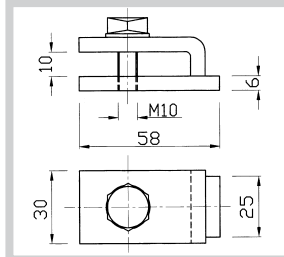
	DESCRIPTION	CODE	MIN. PACK QTY.	DIMENSIONS
	<b>Bracket</b> ■ Material: galvanized steel ■ Length: 50 mm ■ Length: 80 mm	30607001/05 30607001/08	1 1	
	<b>Support arm bracket</b> ■ Material: galvanized steel	30607004	1	
	<b>Support arm clip</b> ■ Material: galvanized steel  n.2 Terminals for every bracket	30607012	1	
				

### ASSEMBLY EXAMPLE

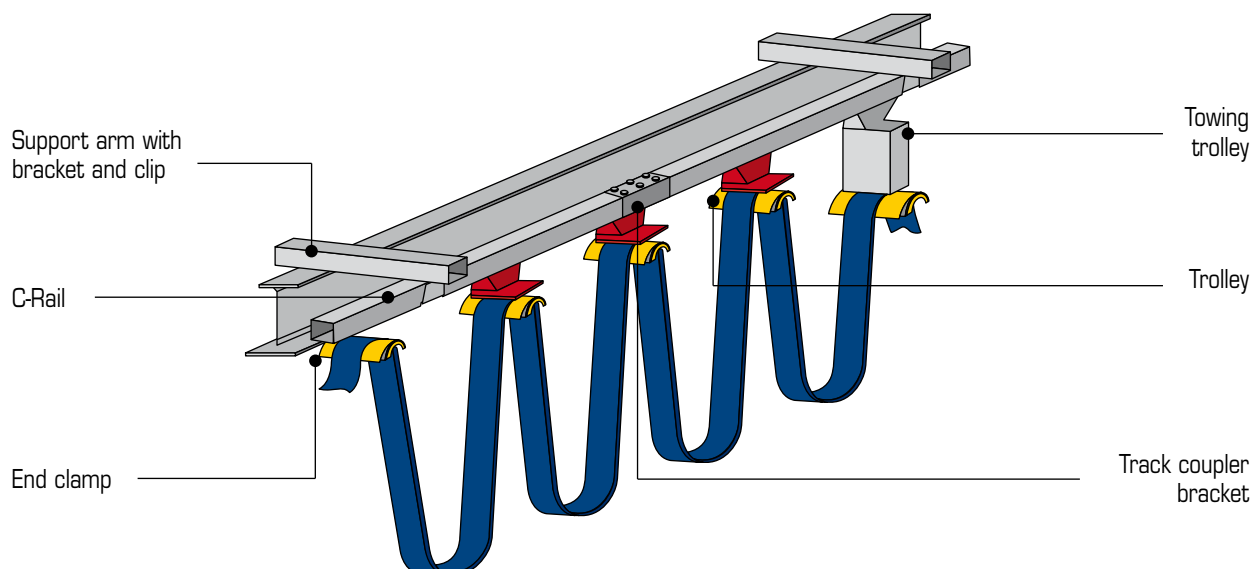



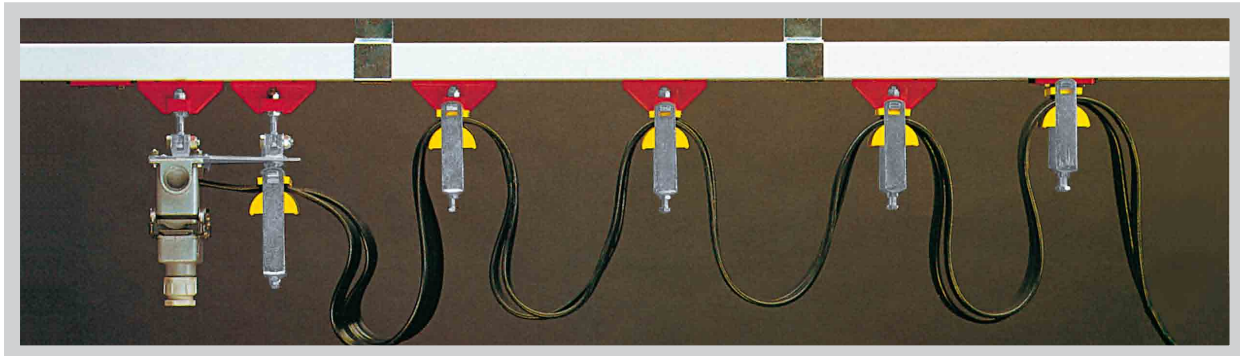

# Energy and data transmission

## 41 Series

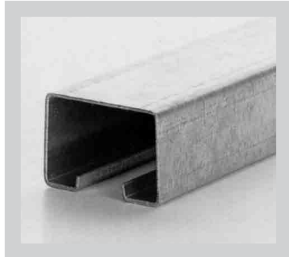
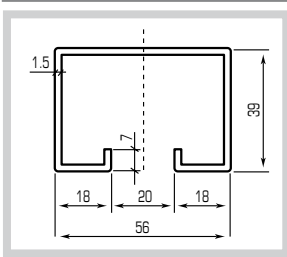
Festoon system

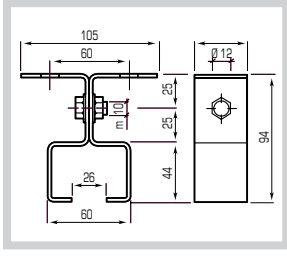

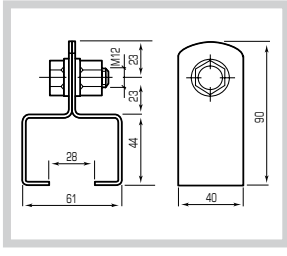
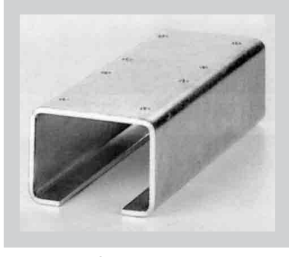
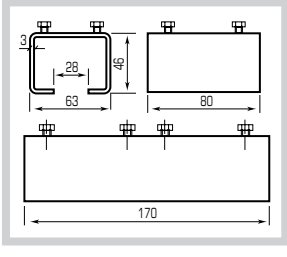
	DESCRIPTION	CODE	MIN. PACK QTY.	DIMENSIONS
	<b>C-Rail bars</b> <ul style="list-style-type: none"> <li>Material: galvanized steel</li> <li>Length: 4 mt</li> <li>Weight: 8 kg</li> <li>Load capacity: 140 kg/mt</li> <li>90° Curve 1,5 mt radius*</li> </ul>	30602001/4	1	
		30602054	1	
	<b>Track support bracket</b> Ceiling fixing 2 pieces Bolts not included <ul style="list-style-type: none"> <li>Material: galvanized steel</li> <li>Max support spacing: (1 mt recommended)</li> </ul>	30602004	1	
	<b>Track support bracket</b> Wall fixing Bolts not included <ul style="list-style-type: none"> <li>Material: galvanized steel</li> <li>Max support spacing: (1 mt recommended)</li> </ul>	30602003	1	
	<b>Track coupler bracket</b> To join c-rail and suitable for supporting the track <ul style="list-style-type: none"> <li>Material: galvanized steel</li> </ul>	30602002	1	
	<b>Double track coupler bracket</b> Recommended for track over 50 mt <ul style="list-style-type: none"> <li>Material: galvanized steel</li> </ul>	30602034	1	

\*The use of the curve requires a mechanical adjustment during assembly line.





# Energy and data transmission

## 41 Series

Festoon system

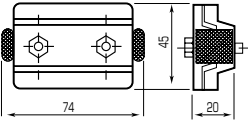

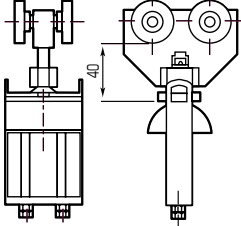

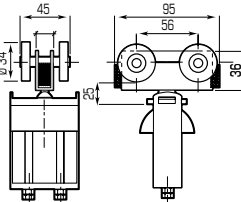

TECHNO-LIFTING EQUIPMENT

	DESCRIPTION	CODE	MIN. PACK QTY.	DIMENSIONS
	<p>End stop</p> <ul style="list-style-type: none"> <li>Material: Support PVC buffer</li> </ul>	<p>30602038</p>	<p>1</p>	
	<p><b>Flat cable trolley</b></p> <ul style="list-style-type: none"> <li>Material: PA 6</li> <li>Type of trolley: PA roller. Travel speed 60m/min.</li> <li>Load capacity: 15 kg</li> <li><b>40 mm: Plastic saddle</b></li> <li><b>55 mm: Plastic saddle</b></li> <li>Range 50 mm</li> </ul> <p><b>Round cable trolley</b></p> <ul style="list-style-type: none"> <li>Material: PA 6</li> <li>Type of trolley: PA roller. Travel speed 60m/min.</li> <li>Load capacity: 15 kg</li> <li><b>40 mm: Plastic saddle</b></li> <li><b>55 mm: Plastic saddle</b></li> <li>Range 50 mm</li> </ul>	<p>30602012</p> <p>30602014</p>	<p>10</p> <p>10</p>	
	<p><b>Flat cable trolley</b></p> <ul style="list-style-type: none"> <li>Material: galvanized steel</li> <li>Sliding: ball bearings travel speed 120m/min.</li> <li>Load capacity: 25 kg</li> <li><b>40 mm: Plastic saddle</b></li> <li><b>55 mm: Plastic saddle</b></li> <li><b>68 mm: Plastic saddle</b></li> </ul> <p><b>Round cable trolley</b></p> <ul style="list-style-type: none"> <li>Material: galvanized steel</li> <li>Sliding: ball bearings travel speed 120m/min.</li> <li>Load capacity: 25 kg</li> <li><b>40 mm: Plastic saddle</b></li> <li><b>55 mm: Plastic saddle</b></li> </ul>	<p>30602076</p> <p>30602077</p> <p>30602086</p>	<p>10</p> <p>10</p> <p>10</p>	

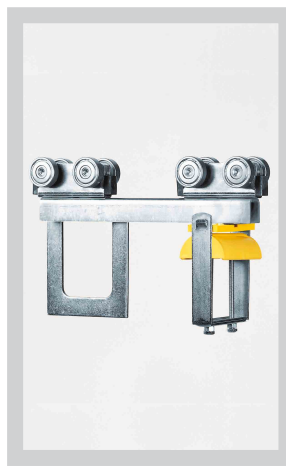
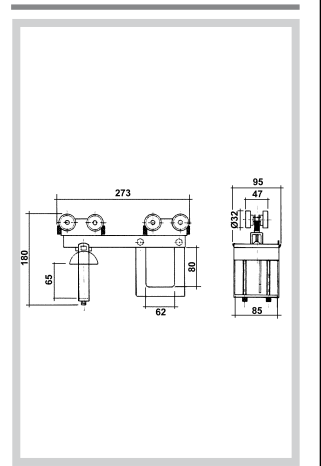
# Energy and data transmission

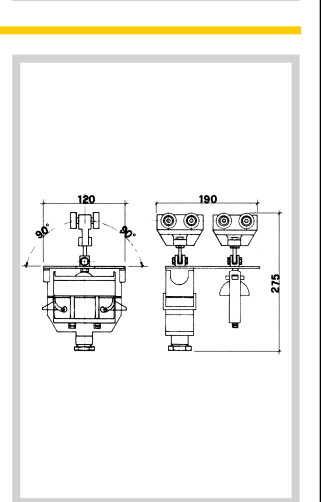
## 41 Series Festoon system

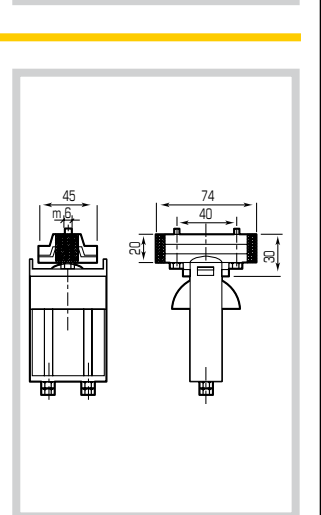
	DESCRIPTION	CODE	MIN. PACK QTY.	DIMENSIONS
	<p><b>Towing trolley</b></p> <ul style="list-style-type: none"> <li>■ Material: galvanized steel</li> <li>■ Sliding: ball bearings</li> <li>■ 68 mm Plastic saddle Range 50 mm</li> <li>■ Twin execution</li> <li>■ Single execution</li> </ul>	<p>30602020</p> <p>30602091</p>	<p>1</p> <p>1</p>	
	<p><b>Trolley with safety plug and socket</b></p> <p>To connect the festoon system to the pendant station</p> <ul style="list-style-type: none"> <li>■ 68 mm Plastic saddle</li> <li>■ 16 Poles</li> <li>■ 24 Poles</li> </ul>	<p>30602036</p> <p>30602040</p>	<p>1</p> <p>1</p>	
	<p><b>End clamp</b></p> <ul style="list-style-type: none"> <li>■ Material: PA 6 and galvanized steel</li> <li>■ Load capacity: 15 kg</li> <li>■ 40 mm Plastic saddle</li> <li>■ 55 mm Plastic saddle</li> <li>■ 68 mm Plastic saddle</li> <li>■ Range 50 mm</li> </ul>	<p>30602006</p> <p>30602007</p> <p>30602092</p>	<p>1</p> <p>1</p> <p>1</p>	



# Energy and data transmission

## 41 Series Inox

Festoon system

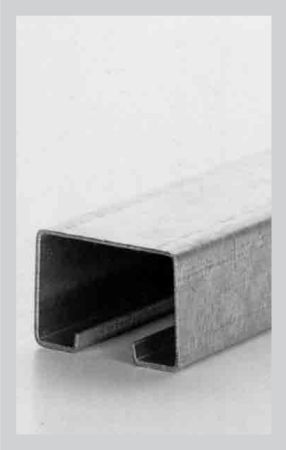
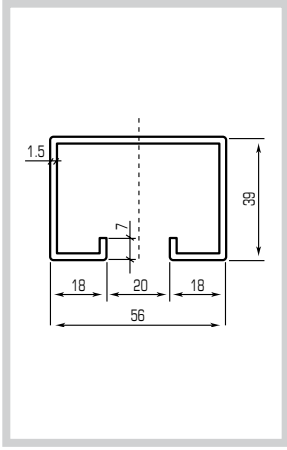

TECHNO-LIFTING EQUIPMENT

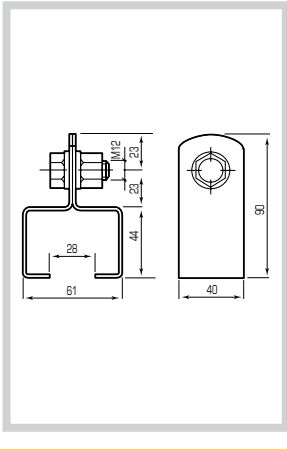
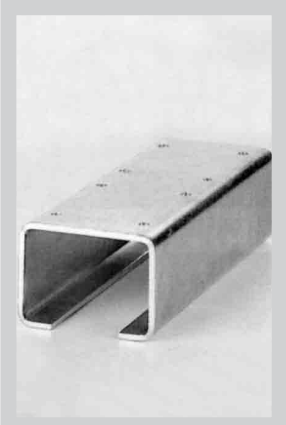
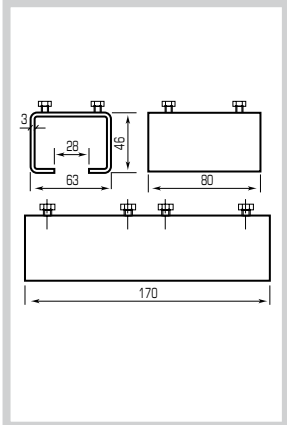
	DESCRIPTION	CODE	MIN. PACK QTY.	DIMENSIONS
	<p><b>C-Rail bars</b></p> <ul style="list-style-type: none"> <li>Material: stainless steel</li> <li>Length: 3 m</li> <li>Weight: 8 kg</li> <li>Load capacity: 140 kg/m</li> </ul>	30602061	1	
	<p><b>Inox track support bracket</b></p> <p>Ceiling fixing 2 pieces Bolts not included</p> <ul style="list-style-type: none"> <li>Material: stainless steel</li> <li>Max support spacing: 1 mt recommended</li> </ul>	30602063	1	
	<p><b>Inox track support bracket</b></p> <p>To join c-rail</p> <ul style="list-style-type: none"> <li>Material: stainless steel</li> <li>Single track coupler bracket</li> <li>Double track coupler bracket Recommended for track over 50 mt</li> </ul>	<p>30602065</p> <p>30602062</p>	<p>1</p> <p>1</p>	

# Energy and data transmission

## 41 Series Inox

Festoon system

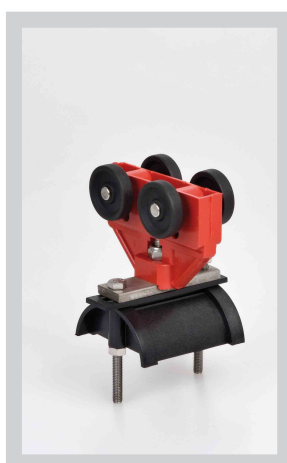

### DESCRIPTION

#### Inox flat cable trolley

- Material: PA 6/stainless steel
- Type of trolley: PA roller.  
Travel speed 60m/min.
- Load capacity: 25 kg
- 55 mm Plastic saddle

### CODE

30602064

### MIN. PACK QTY.

1

### DIMENSIONS

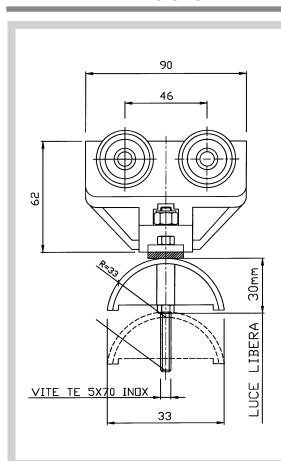

#### Towing trolley

- Material: PA 6/stainless steel
- Type of roller: steel rollers with ball
- 55 mm Plastic saddle

30602067

1

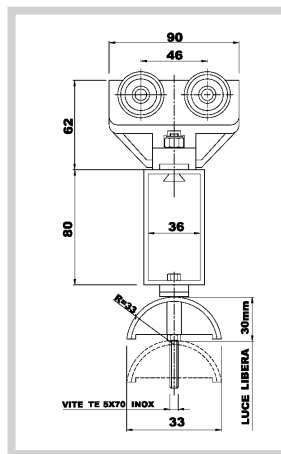

#### End clamp

- Material: PA 6/stainless steel
- Load capacity: 15 kg
- 55 mm Plastic saddle

30602066

1

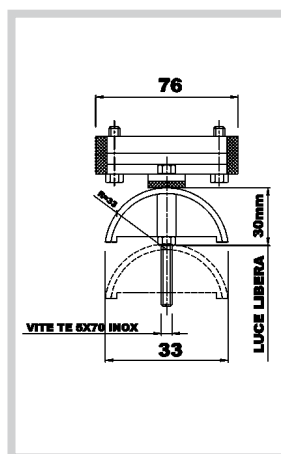

# Energy and data transmission

## Wire rope Series

Ø 8 Rope fastoon system





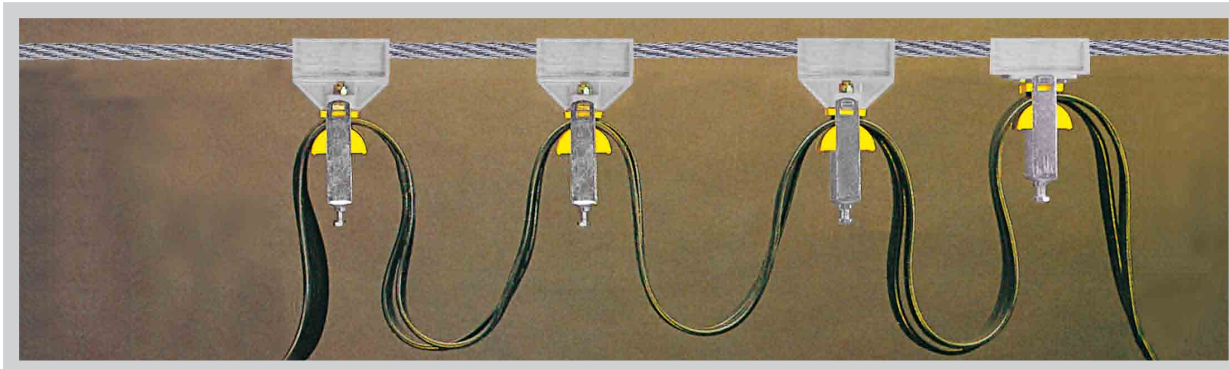

TECHNO-LIFTING EQUIPMENT

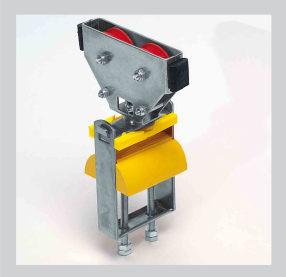
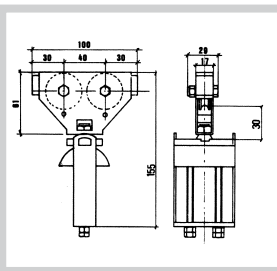

### CHARACTERISTICS

Wire rope fastoon system are used in cases where c-rail and i-beam track power supplies are difficult to install.

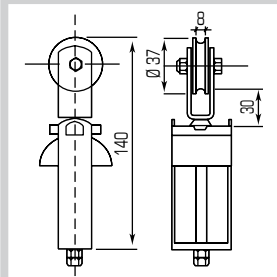
- Rope diameter: Ø 8
- Trolley for flat or round cable
- Travel speed: 40 m/min.
- Load capacity: 8 kg

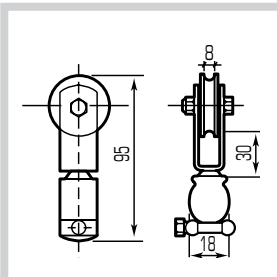
	DESCRIPTION	CODE	MIN. PACK QTY.	DIMENSIONS
	<p><b>Two rollers trolley</b></p> <ul style="list-style-type: none"> <li>■ Material: PA6 and galvanized steel</li> <li>■ Type of roller: PA roller</li> <li>■ Rotating 55 mm plastic saddle</li> <li>■ Range 50 mm</li> </ul>	30604003	10	
	<p><b>One roller trolley</b></p> <ul style="list-style-type: none"> <li>■ Material: PA6 and galvanized steel</li> <li>■ Type of roller: PA roller</li> <li>■ Rotating 40 mm plastic saddle</li> <li>■ Range 50 mm</li> </ul>	30604005	10	
	<p><b>Single roller trolley with metal cable clip</b></p> <ul style="list-style-type: none"> <li>■ Material: PA6 and galvanized steel</li> <li>■ Type of roller: PA roller</li> <li>■ Rope max: 18mm</li> </ul>	30604007	10	

# Energy and data transmission

## Light Series

### I-Beam

#### CHARACTERISTICS

- The FASTOON SYSTEM with steel sliding IPE-IPN are suitable for installation in industries where heavy duty is required (power of mobile equipment in steel mills, cranes, rolling mills, foundries, storage containers, etc.)
- IPE-IPN 80÷120 beam
- Travel speed: 120 m/min.
- Max trolley load capacity: 200 kg
- Max cable package window opening height of 70 mm for both flat and round cable

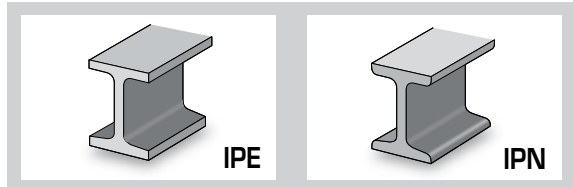

TROLLEY				
BEAM	IPE 80		IPN 80	
Saddle mm	55	85	55	85
PA Rollers	30606003	30606005	30606004	30606006
Steel rollers	30606103	30606105	30606104	30606106
BEAM	IPE 100		IPN 100	
Saddle mm	55	85	55	85
PA Rollers	30606011	30606013	30606012	30606014
Steel rollers	30606111	30606113	30606112	30606114

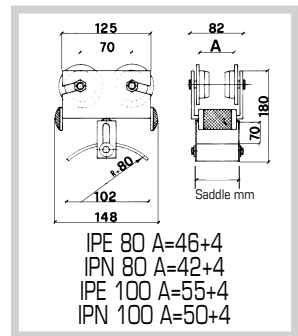

TOWING TROLLEY				
BEAM	IPE 80		IPN 80	
Saddle mm	55	85	55	85
PA Rollers	30606033	30606035	30606034	30606036
Steel rollers	30606133	30606135	30606134	30606136
BEAM	IPE 100		IPN 100	
Saddle mm	55	85	55	85
PA Rollers	30606041	30606043	30606042	30606044
Steel rollers	30606141	30606143	30606142	30606144

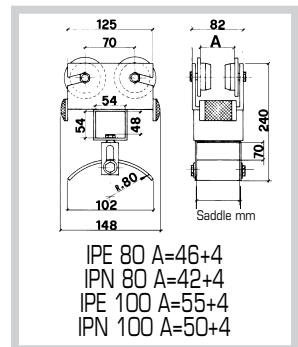

END CLAMP				
BEAM	IPE 80 - IPN80		IPE 100 - IPN 100	
Saddle mm	55	85	55	85
Code	30606062	30606063	30606066	30606067

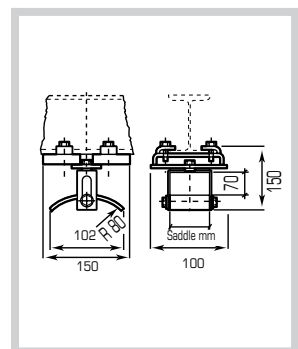



# Energy and data transmission

## Heavy Series

I-Beam



TECHNO-LIFTING EQUIPMENT

### CHARACTERISTICS

- The FASTOON SYSTEM with steel sliding IPE-IPN are suitable for installation in industries where heavy duty is required (power of mobile equipment in steel mills, cranes, rolling mills, foundries, storage containers, etc.)
- IPE-IPN 80-120 beam
- Travel speed: 120 m/min.
- Max trolley load capacity: 200 kg
- Max cable package window opening height of 50 mm for both flat and round cable

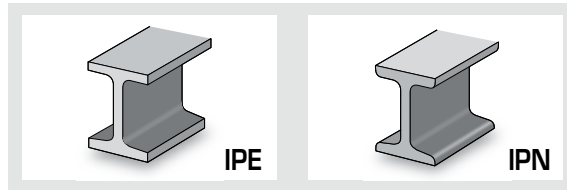

TROLLEY				
BEAM	IPE 80		IPN 80	
Saddle mm	100	160	100	160
Steel rollers	30605001	30605002	30605003	30605004
BEAM	IPE 100		IPN 100	
Saddle mm	160	180	160	180
Steel rollers	30605005	30605006	30605007	30605008
BEAM	IPE 120		IPN 120	
Saddle mm	160	180	160	180
Steel rollers	30605009	30605010	30605011	30605012

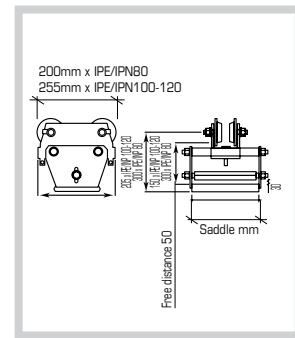

TRAINO				
BEAM	IPE 80		IPN 80	
Saddle mm	100	160	100	160
Steel rollers	30605013	30605014	30605015	30605016
BEAM	IPE 100		IPN 100	
Saddle mm	160	180	160	180
Steel rollers	30605017	30605018	30605019	30605020
BEAM	IPE 120		IPN 120	
Saddle mm	160	180	160	180
Steel rollers	30605021	30605022	30605023	30605024

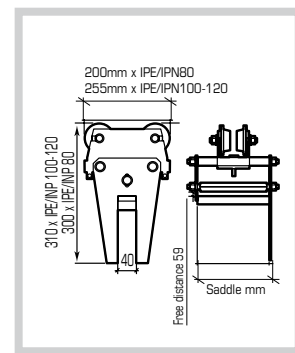

END CLAMP		
BEAM	IPE 80 - IPN 80	
Saddle mm	100	160
Steel rollers	30605025	30605026
BEAM	IPE 100 - IPN 100	
Saddle mm	160	180
Steel rollers	30605027	30605028
BEAM	IPE 120 - IPN 120	
Saddle mm	160	180
Steel rollers	30605029	30605030

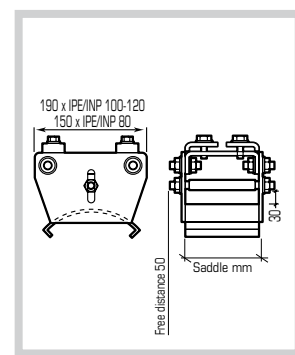

# Energy and data transmission

## Series festoon 28 - 30 - 41 and on i-beam

Assembly example

### LINES DIAGRAMS

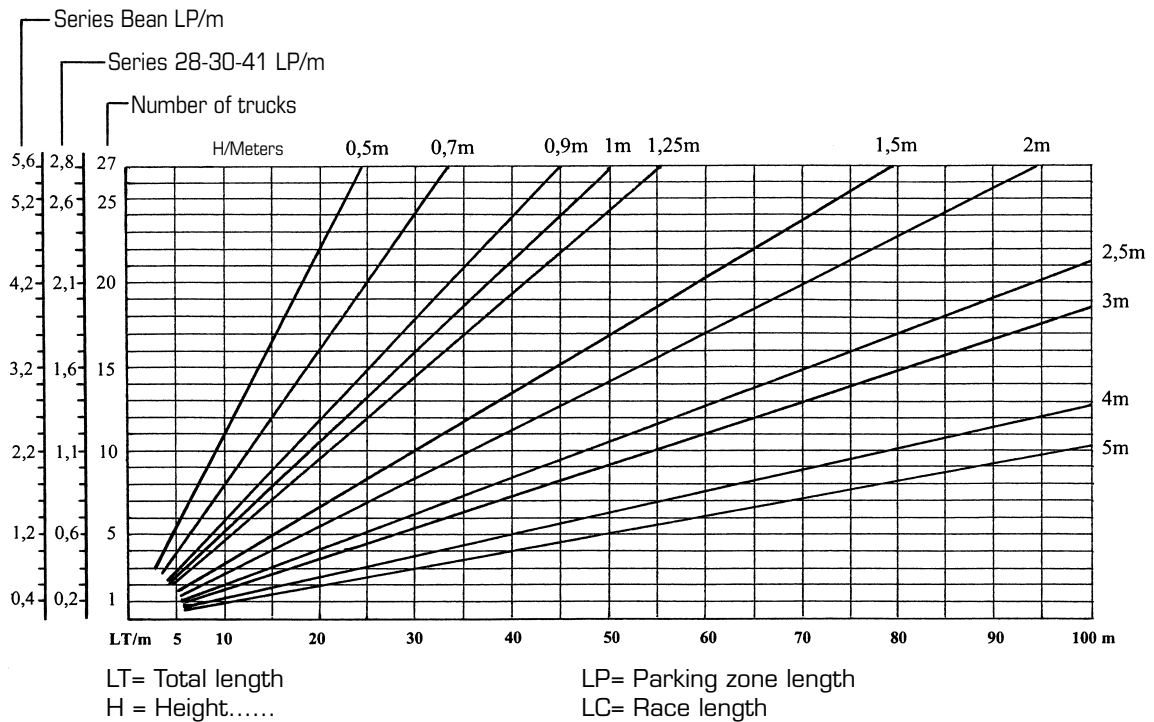
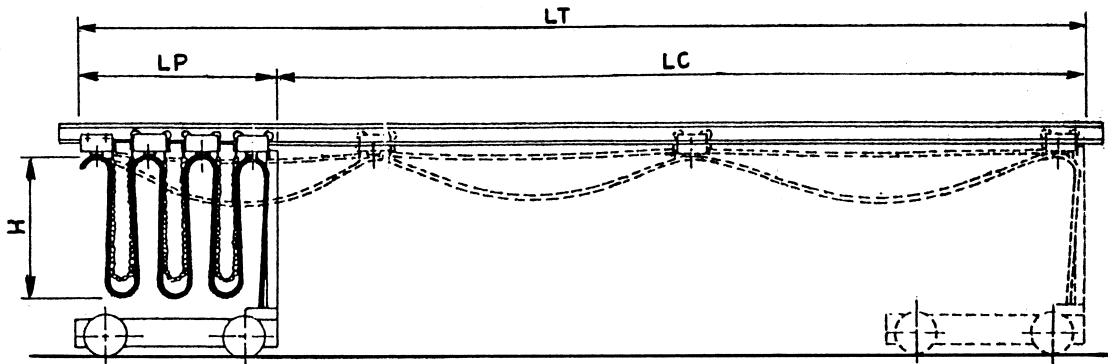

The diagram is used to determine the number of trucks necessary for the formation of the line, depending on its length. The height of the loop determines how many trucks are needed and thus their parking area. Where the parking area is too long at the expense of running real user, it must increase the height of the loops, thus decreasing the number of trucks required and therefore the parking area. To determine the cable length of a garland to increase by 10% the total length of the line and add enough to connect the two ends of the fixed and mobile users.

# Energy and data transmission

## TR85 Trolley Series

From 40A to 200A



TECHNO-LIFTING EQUIPMENT

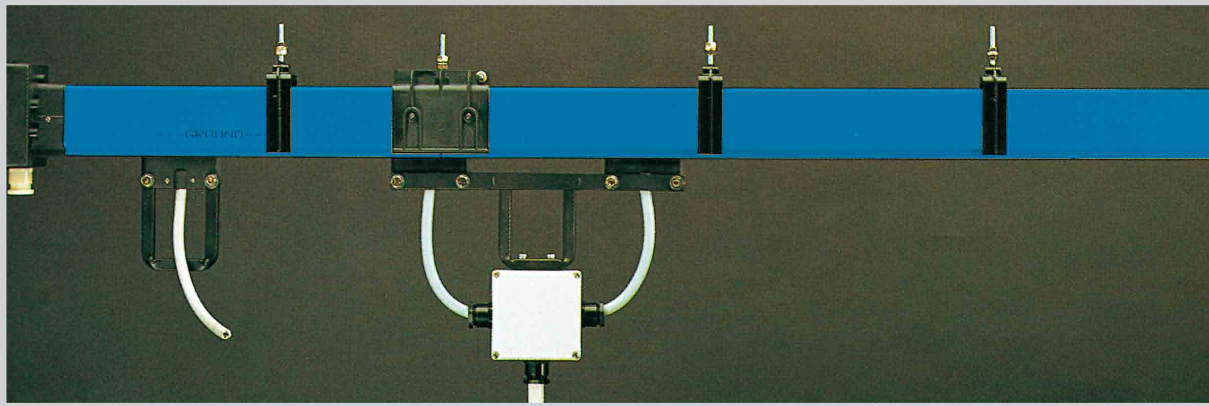

### GENERAL CHARACTERISTICS

The TR85 Series conductors rails are modern and safe system for energy and data transmission for various types of equipment such as: cranes - bridge cranes - conveyour belts - chain conveyors - etc... The TR85 range comply with the relevant international standards ensuring operator safety, easy of installation and reliability. the system is available in the following versions:

- **Line A blue colour** - with conductors preinserted inside the plastic casing. copper strips are connected by means of dedicated terminals.
- **Line B yellow colour** - with conductors strip to be pulled from a coil continuously into the pre-assembled plastic casings with the aid of a towing trolley in case of long systems.

### GENERAL CHARACTERISTICS

		40	70	100	140	200
■ Operating current 23°C	A	40	70	100	140	200
■ Comply with rules		CEI EN 60439-1 e 2, CEI EN 60695-2-1., CEI EN 60570				
■ Rated operating voltage Ue	V	600V ac				
■ Frequency	Hz	50 Hz				
■ Conditional rated short circuit withstand current	kA	10	10	10	10	10
■ Fuse rating gG	A	40	70	100	160	200
■ Rated short-time current Icw	A	600	900	1400	1800	2500
■ Protection class CEI EN 60529:						
■ Standard execution		IP13				
■ Execution with rubber		IP23				
■ Flammability resistance	UL 94	V0				
	CEI EN 60695-2-1. °C	960				
■ Ambient temperature: operating	°C	- 30 + 55				
	storage	- 30 + 70				
■ Admissible current collector trolley speed	m/min. <sup>1</sup>	200				
■ Conductor Cu	mm <sup>2</sup>	9,3	15,5	21,7	31	46,5
■ Resistance	$\Omega/m \cdot 10^{-4}$	18,27	10,96	7,83	5,48	3,65
■ Impedance	$\Omega/m \cdot 10^{-4}$	18,36	11,01	7,87	5,55	3,67

# Energy and data transmission

## TR85 Trolley Series

From 40A to 200A

### PVC RAIL TRACK CHARACTERISTICS

Material	Rigid PVC	
Self-extinguishing	UL 94 DIN 4102 D.M.6/7/83	VO B2 Cl
Ultimate tensile strenght	ISO R527 23°C	430 kg/cm <sup>3</sup>
Yield point	ISO R527 23°C	460 kg/cm <sup>2</sup>
Modulus of elasticity	ISO R178 23°C	30000 kg/cm <sup>2</sup>
Impact resistance	DIN 53453	Unbroken
Dielectric strenght	ASTM 149	25 kV/mm
Softening temeperature - Vicat	ISO R306 49N	82°C

### CONDUCTORS BARS WEIGHT TABLE

N° CONDUCTORS	WEIGHT PER LINEAR METER/RANGE				
	40A	70A	100A	140A	200A
4	1,680 kg/m	1,902 kg/m	2,122 kg/m	2,454 kg/m	3,010 kg/m
5	1,764 kg/m	2,050 kg/m	2,305 kg/m	2,730 kg/m	3,423 kg/m

### CALCULATION OF THE VOLTAGE DROP

Voltage drop should not exceed 5% of rated voltage under normal operating.

#### 3 Phase AC

$$\Delta u = \sqrt{3} \times I \times L_t \times Z$$

$$\Delta u \% = \frac{\Delta u \times 100}{U}$$

#### WHERE

$\Delta u$	= Voltage drop	(V)
$\Delta u \%$	= Voltage drop	(%)
I	= Intensity	(A)
$L_t$	= Length of section (m)	(m)
Z	= Impedance	( $\Omega$ /m)
U	= Voltage	(U)

### RAIL TRACK LINES POWER

A proper disposal of power feed points allow voltage drop reduction.

If L is the length of the line,  $L_t$  is the track maximum length to consider the voltage drop.

$L_t = L$	With end power feed
$L_t = L/2$	With line power feed
$L_t = L/6$	With power feed 1/6 at each end
$L_t = L/10$	With three power feed at L / 2 and L/10 from each end

System with end power feed



Two power feed 1/6 from each end

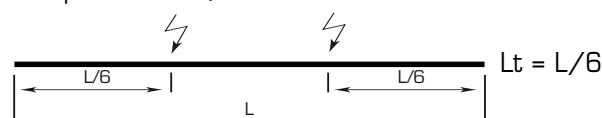

System with line power feed

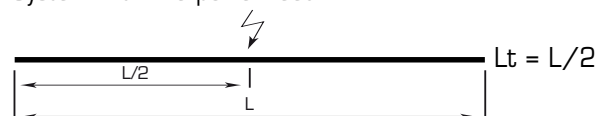

Three power feed at L/2 and L/6 from each end



# Energy and data transmission

## TR85 Trolley Series

Line construction



TECHNO-LIFTING EQUIPMENT

### LINE CONSTRUCTION

To define the size of trolley line TR85, is necessary to consider:

- Maximum current in service
- Devices (motors cage, ring, resistors, electronic starters)
- Devices starting currents
- Maximum ambient temperature
- The distance between device and nearest power feed
- Admissible voltage and voltage dropping in starting and continuous service
- Type of current
- Devices cycle operations (load factor)

### CURRENT IN CONTINUOUS SERVICE

Specify devices number which work simultaneously to calculate the corresponding current:

$$I_N = I_1 + I_2 + \dots + I_n$$

The current can be determined from the devices power (w) that for a three-phase system is:

$$I_N = \frac{P_u}{\sqrt{3} \cdot U \cdot \cos \varphi \cdot \eta}$$

$I_N$	Current Consumption - Amper
$P_u$	Power devices - Watts
$\eta$	Devices performances
$U$	Operating voltage in volts
$\cos \varphi$	Power factor

In the absence of information on the simultaneous devices operations, consider following table:

Lifting numbers devices on line	LIFTING EQUIPMENTS IN USE			
	1st ENGINE Engine max. power (*)	2nd ENGINE	3rd ENGINE	4th ENGINE
1	x	x		
2	x	x	x	
3	x	x	x	
4	x	x	x	x
5	x	x	x	x
no.2 lifting equipments operating in contemporary	x	x	x	x

(\*) To drag n parallel motors rated current  $I_n'$ , consider  $I_N = n \cdot I_n'$

# Energy and data transmission

## TR85 Trolley Series

Line construction

### LINE CONSTRUCTION

#### STARTING CURRENT

Calculate devices numbers in simultaneously started and already in service, then calculate the corresponding current. When the starting current is unknown, proceed with the following approximation:

$$I_a = K \cdot I_n \quad \text{for a single user}$$

Where  $K = \frac{\text{Starting current (I}_a\text{)}}{\text{Nominal current (I}_n\text{)}}$  As a general rule, consider:  
 $K = 5$  to  $6$  for the cage motors,  
 $K = 2$  rotors winding motors  
 $K = 2$  with frequency converters

In the absence of information on the simultaneous operation of utilities relate to the following table:

Lifting numbers devices on line	LIFTING EQUIPMENTS IN USE							
	1st ENGINE		2nd ENGINE		3rd ENGINE		4th ENGINE	
	I <sub>a</sub>	I <sub>n</sub>	I <sub>a</sub>	I <sub>n</sub>	I <sub>a</sub>	I <sub>n</sub>	I <sub>a</sub>	I <sub>n</sub>
1	X			X				
2	X			X		X		
3	X		X					
4	X		X			X		
5	X		X			X		X
no.2 lifting equipments operating in contemporary	X		X			X		X

#### LINE SCHEMATIC EXAMPLE

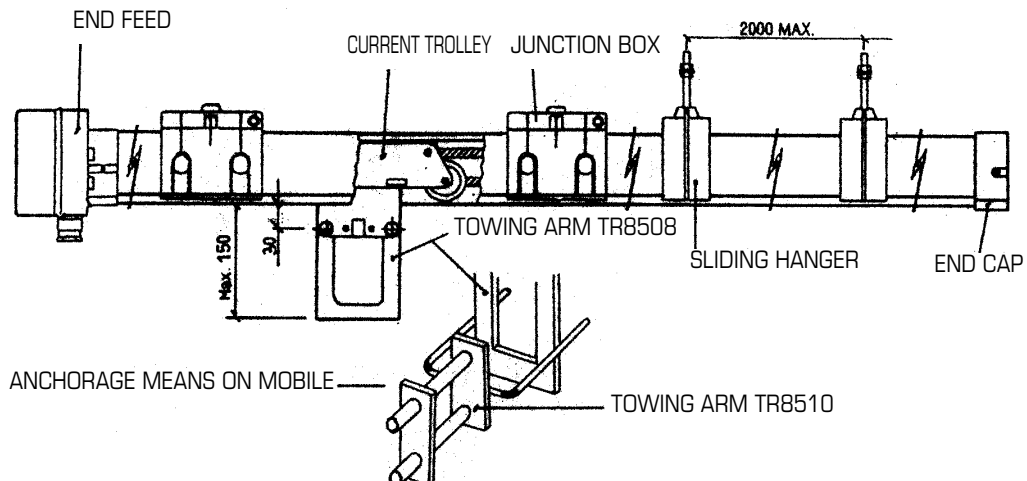

# Energy and data transmission

## TR85 Trolley Series

### Examples



TECHNO-LIFTING EQUIPMENT

### GENERAL CHARACTERISTICS

to define line overall length is necessary to consider the standard modular length, festoons, except the curves, which obtain with PVC conductors 40A to 140A, 3 and 4 meters, 200A only 4 meters. The real length of the line will therefore be higher or lower than the theoretical length assumed or required.

Sample order and composition of a line following the scheme indicated.

### TR85 TROLLEY SERIES A LINE FROM 70A TO 4 CONDUCTORS

- ① Sector mt 15,250 = 15.250 mm  
 15.250 mm - 85 mm (Power feed) = 15.165 mm  
 no. 3 rail tracks 4 m = 12.000 mm TR85704C  
 no. 1 rail tracks 3 m = 3.000 mm TR85704C3  
 12.000 mm + 3.000 mm = 15.000 mm - 15.165 mm = - 165 mm

- ② Sector mt 8,750 = 8.750 mm  
 no. 3 rail tracks 3 m = 9.000 mm TR85704C3  
 9.000 mm - 8.750 mm = + 250 mm (exceeding)

- ③ Sector mt 7,00 = 7.000 mm  
 15.250 mm - 290 mm (Power feed) = 14.960 mm  
 no. 1 rail tracks 4 m = 4.000 mm TR85704C  
 no. 1 rail tracks 3 m = 3.000 mm TR85704C3  
 7.000 mm - 7.000 mm = 0

Total rail track: ①+②+③ Sector = 31m = n.5 rail tracks  
 from 3m + no.4 rail tracks to 4m

- Curve** R. 2.200 mm = L 3.455 mm TR8529704D90  
**Curve** R. 1.200 mm = L 1.885 mm TR8529704A90

- Power feed** from 40A to 140A no.1 TR 8503A4  
**End cap** from 40A to 200A no.1 TR 8506A  
**Sliding hanger** from 40A to 140A in Plastic no. 17 pcs (\*) TR 8502  
 from 40A to 140A in Metal no. 17 pcs (\*) TR 8525  
**Junction box** from 40A to 200A in PA no. 10 pcs (\*) TR 8504  
**Junctions box** n. is in base of PVC rail tracks number + 2

- (\*) Add n. 2 sliding hanger every Curve with radius from 1.2 to 1.8 meters,  
 R. 1.200 to 1.800 mm, n.3 Sliding hangers every Curve with radius 2.2meters  
 R. 2.200 mm

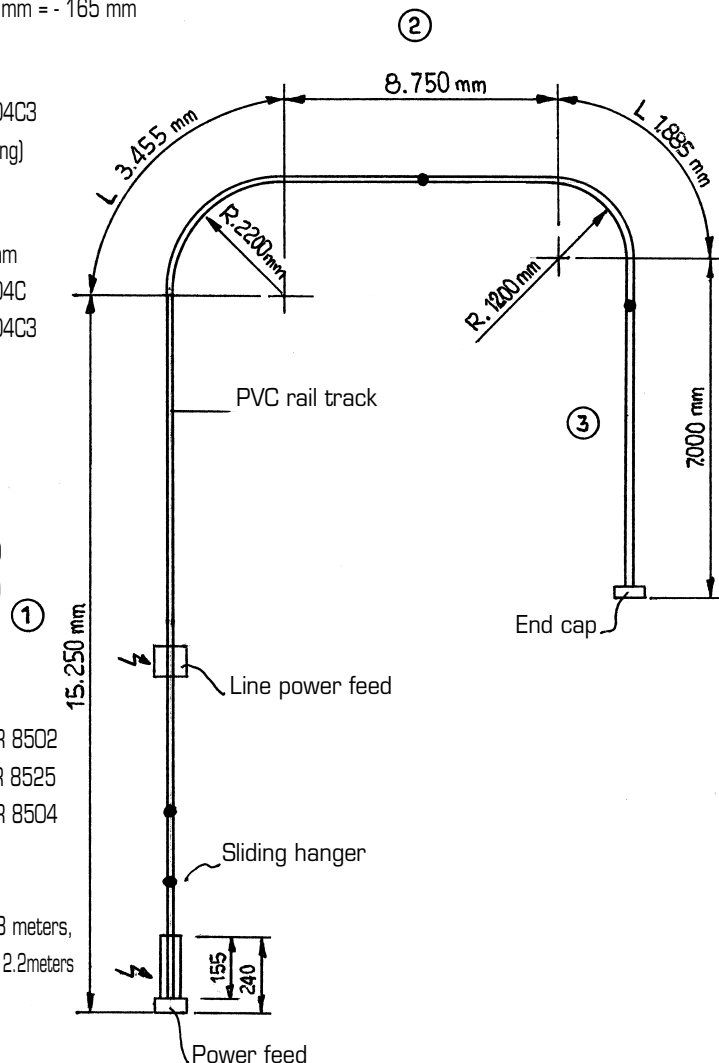

# Energy and data transmission

## TR85 Trolley Series

Conductor rails - Line A "plug-in" type

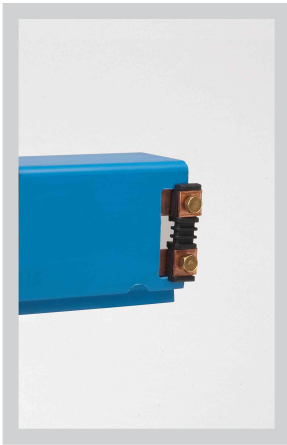

### CONDUCTOR RAIL INSULATING INTERMEDIATE 40A - 70A - 100A - 140A

L IN METERS	N° CONDUCTORS	REACH	
		40A	70A
3	4	TR85404C3	TR85704C3
	5	TR85405C3	TR85705C3
4	4	TR85404C	TR85704C
	5	TR85405C	TR85705C

L IN METERS	N° CONDUCTORS	REACH	
		100A	140A
3	4	TR851004C3	TR851404C3
	5	TR851005C3	TR851405C3
4	4	TR851004C	TR851404C
	5	TR851005C	TR851405C

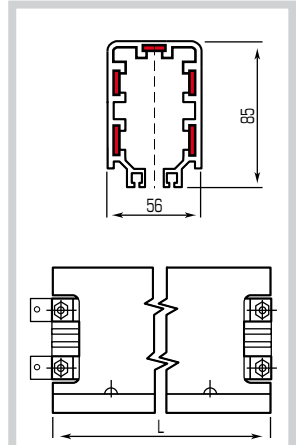

40A.....140A Series



### BAR INSULATING INTERMEDIATE 200A

L IN METERS	N° CONDUCTORS	REACH 200A
3	4	TR852004C3
	5	TR852005C3
4	4	TR852004C
	5	TR852005C

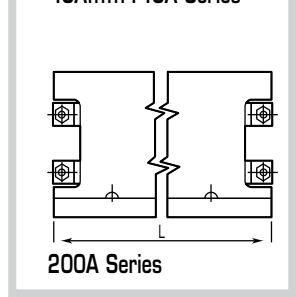

200A Series



### POWER

Standard length 200 mm

L IN mm	N° CONDUCTORS	REACH
		40A....140A
200	4	TR8503A4
	5	TR8503A5

L IN mm	N° CONDUCTORS	REACH
		200A
200	4	TR8533A4
	5	TR8533A5

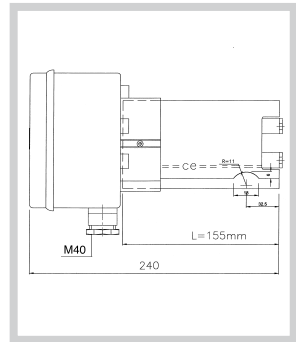

### CLOSING

Standard length 100 mm

Closed neutral Rails at 4 and 5 Conductors from 40A to 200A

CODE MIN. PACK QTY.

TR8506A

1

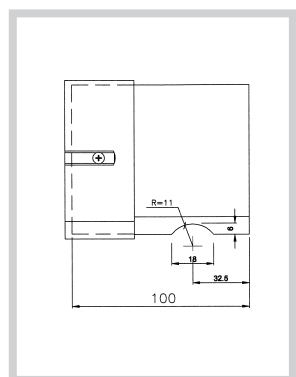









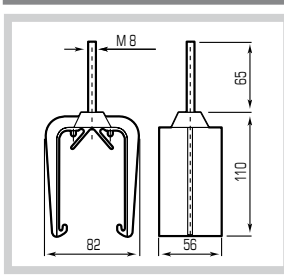

# Energy and data transmission

## TR85 Trolley Series

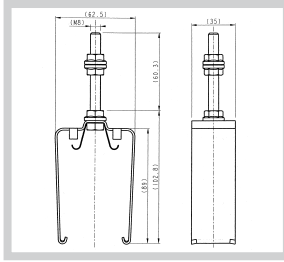
Conductor rails - Line A "plug-in" type

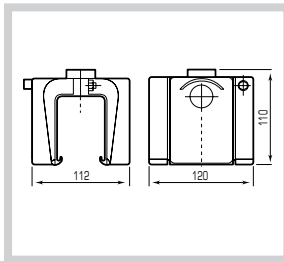

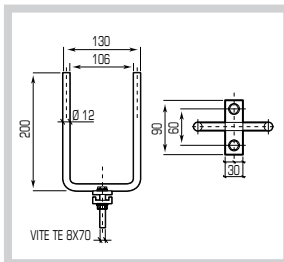

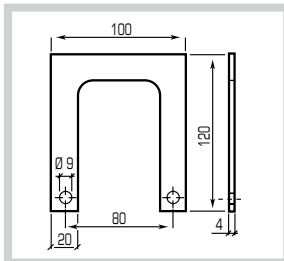

TECHNO-LIFTING EQUIPMENT

	DESCRIPTION	CODE	MIN. PACK QTY.	DIMENSIONS
	<p><b>Hanger clamp</b> only for 40A a 140A</p> <ul style="list-style-type: none"> <li>Material: PA 66</li> <li>Max support spacing 2 mt (reccomended)</li> </ul>	TR8502	1	
	<p><b>Steel hanger clamp</b></p> <ul style="list-style-type: none"> <li>Material: PA6 and galvanized steel</li> <li>For series from 40A to 140A max support spacing 2 mt (reccomended)</li> <li>Series 200A n.1 max support spacing 1 mt (reccomended)</li> </ul>	TR8525	1	
	<p><b>Joint cover</b></p> <p>For to join the end of two conductor rails</p> <ul style="list-style-type: none"> <li>Material: PA 66</li> </ul>	TR8504	1	
	<p><b>Towing arm</b></p> <ul style="list-style-type: none"> <li>Material: galvanized steel</li> </ul>	TR8510	1	
	<p><b>Towing arm bracket</b></p> <p>For 35A and 70A current collectors</p> <ul style="list-style-type: none"> <li>Material: galvanized steel</li> </ul>	TR8508	1	

# Energy and data transmission

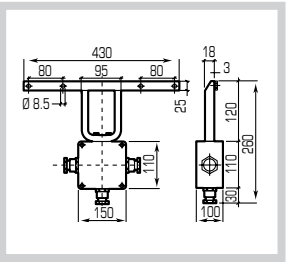
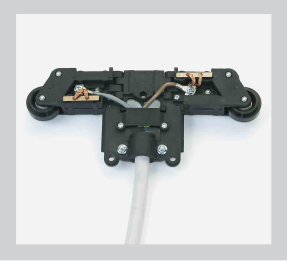
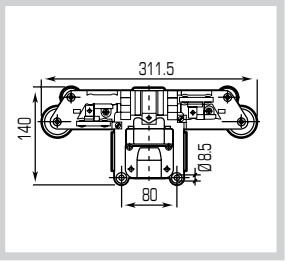
## TR85 Trolley Series

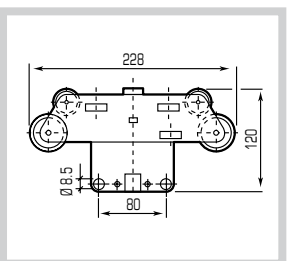
Conductor rails - Line A "plug-in" type

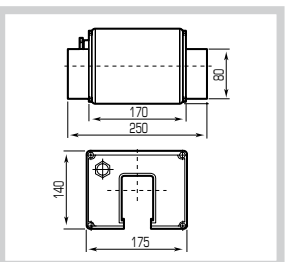
	DESCRIPTION	CODE	MIN. PACK QTY.	DIMENSIONS
	<p><b>Support for double towing arm</b></p> <p>Connects two trolley in parallel to increase current rating</p> <ul style="list-style-type: none"> <li>For 35A and 70A current collector trolley</li> </ul>	TR8523	1	
	<p><b>70A Current collector trolley</b></p> <ul style="list-style-type: none"> <li>Fully insulated body with copper graphite collector shoes.</li> <li>Wheels equipped with ball bearings.</li> <li>For current rating over 70A.</li> <li><b>Connect more trolleys on parallel</b></li> </ul> <ul style="list-style-type: none"> <li>70 amp. 3 Poles</li> <li>70 amp. 4 Poles</li> <li>70 amp. 5 Poles</li> </ul>	TR8522 TR8518 TR8519	1 1 1	
	<p><b>35A Current collector trolley</b></p> <ul style="list-style-type: none"> <li>Fully insulated body with copper graphite collector shoes.</li> <li>Wheels equipped with ball bearings.</li> </ul> <ul style="list-style-type: none"> <li>35 amp. 3 Poles</li> <li>35 amp. 4 Poles</li> <li>35 amp. 5 Poles</li> </ul>	TR8521 TR8511 TR8512	1 1 1	
	<p><b>In line feed</b></p> <ul style="list-style-type: none"> <li>Cable entry with Pg 29 cable gland</li> </ul>	TR8526	1	

### CURVE 90° WITH 4 CONDUCTORS

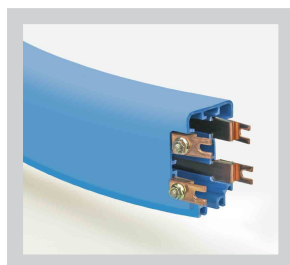

Radius:	40A	70A
R. 1200 mm	TR8529404A90	TR8529704A90
R. 1400 mm	TR8529404B90	TR8529704B90
R. 1800 mm	TR8529404C90	TR8529704C90
(1) R. 2200 mm	TR8529404D90	TR8529704D90
	100A	140A
R. 1200 mm	TR85291004A90	TR85291404A90
R. 1400 mm	TR85291004B90	TR85291404B90
R. 1800 mm	TR85291004C90	TR85291404C90
(1) R. 2200 mm	TR85291004D90	TR85291404D90

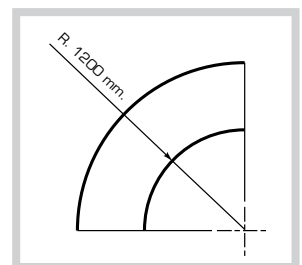

(1) Curve composed by 2 pieces

# Energy and data transmission

## TR85 Trolley Series

Conductor rails - Line B "continuous strip" type



TECHNO-LIFTING EQUIPMENT

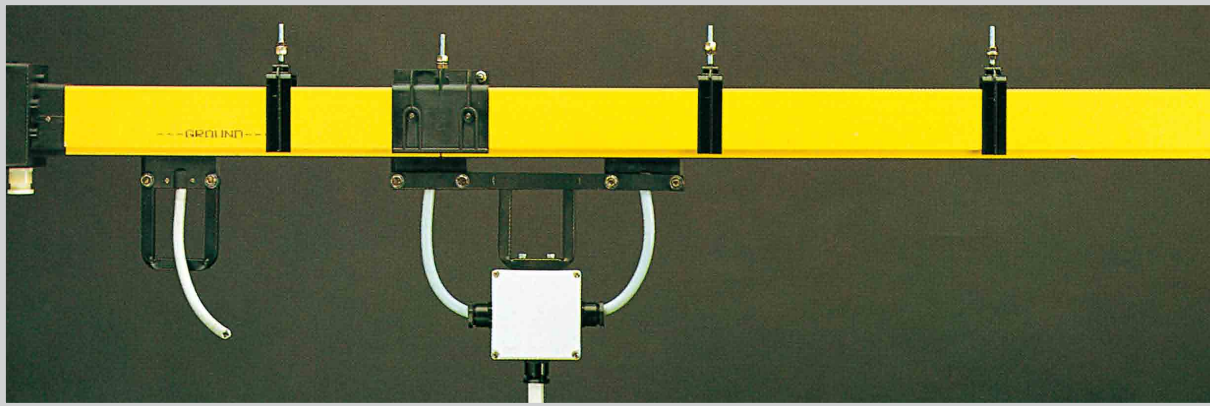

### PVC RAIL TRACK

Conductors are supplied separately. The copper strip is pulled from a coil into the plastic casing with the aid of the TR8513 de-coil unit end TR8514 strip insertion trolley available Series to 140A

Standard length: 4mt

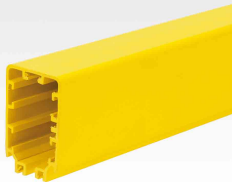

L IN METERS	N° CONDUCTORS	70A	REACH 100A	140A
4	4	TR85704	TR851004	TR851404
	5	TR85705	TR851005	TR851405

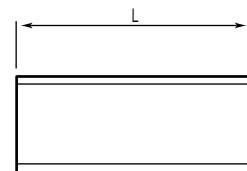
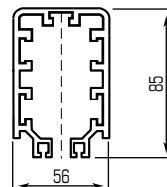

### DESCRIPTION

### CODE

### MIN. PACK QTY.

### DIMENSIONS



#### End feed

- Cable entry with M40 cable gland
- Material: PA 66

TR8503

1

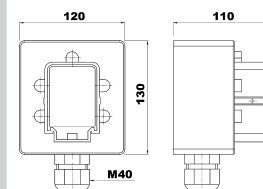

#### End cap

- To close the ends of the line
- Material: PA 66

TR8506



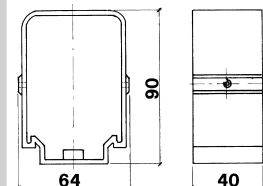



1

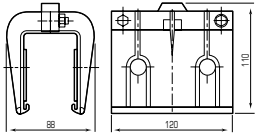
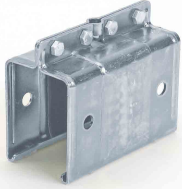
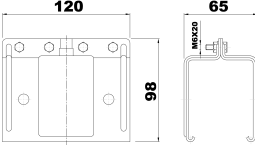

# Energy and data transmission

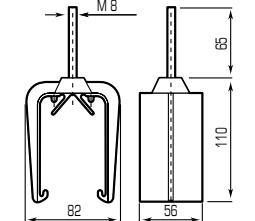
## TR85 Trolley Series

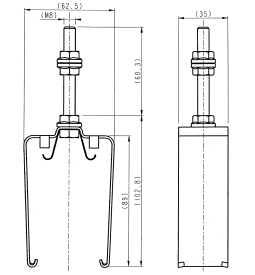
Conductor rails - Line B "continuous strip" type

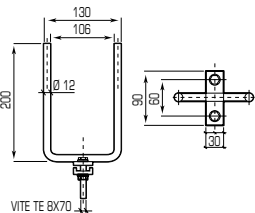
IMAGE	DESCRIPTION	CODE	MIN. PACK QTY.	DIMENSIONS
	<p><b>Joint cover</b> For to join the end of two conductor rails.</p> <hr/> <ul style="list-style-type: none"> <li>Material: PA 66</li> </ul>	TR8501	1	
	<p><b>Steel joint cover</b> For to join the end of two conductor rails</p> <hr/> <ul style="list-style-type: none"> <li>Material: galvanized steel</li> </ul>	TR8524	1	
	<p><b>Hanger clamp</b> Allows the linear expansion due to climate conditions</p> <hr/> <ul style="list-style-type: none"> <li>Max support spacing 2 mt recommended</li> <li>Material: PA 66</li> </ul>	TR8502	1	
	<p><b>Steel hanger clamp</b></p> <hr/> <ul style="list-style-type: none"> <li>Material: PA6 and galvanized steel</li> <li>Mounting space between two hanger clamps for series from 40A to 140A: 1,5 mt max</li> </ul>	TR8525	1	
	<p><b>Towing arm</b></p> <hr/> <ul style="list-style-type: none"> <li>Material: galvanized steel</li> </ul>	TR8510	1	





# Energy and data transmission

## TR85 Trolley Series

Conductor rails - Line B "continuous strip" type

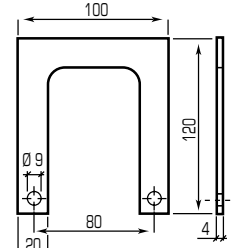

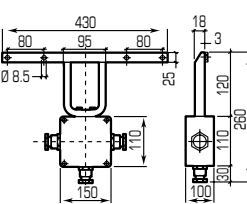

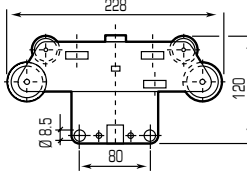
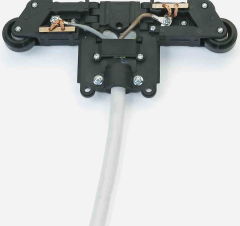
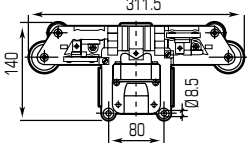

TECHNO-LIFTING EQUIPMENT

IMAGE	DESCRIPTION	CODE	MIN. PACK QTY.	DIMENSIONS
	<p><b>Towing arm bracket</b> For 35A and 70A current collectors</p> <ul style="list-style-type: none"> <li>Material: galvanized steel</li> </ul>	<p>TR8508</p>	<p>1</p>	
	<p><b>Support for double towing arm</b> Connects two trolley in parallel to increase current rating</p> <ul style="list-style-type: none"> <li>For 35A and 70A current collector trolley</li> </ul>	<p>TR8523</p>	<p>1</p>	
	<p><b>35A Current collector trolley</b> fully insulated body with copper graphite collector shoes. Wheels equipped with ball bearings.</p> <ul style="list-style-type: none"> <li>35 amp. 3 Poles</li> <li>35 amp. 4 Poles</li> <li>35 amp. 5 Poles</li> </ul>	<p>TR8521 TR8511 TR8512</p>	<p>1 1 1</p>	
	<p><b>70A Current collector trolley</b> Fully insulated body with copper graphite collector shoes. Wheels equipped with ball bearings. For current rating over 70A. Connect more trolleys on parallel</p> <ul style="list-style-type: none"> <li>70 amp. 3 Poles</li> <li>70 amp. 4 Poles</li> <li>70 amp. 5 Poles</li> </ul>	<p>TR8522 TR8518 TR8519</p>	<p>1 1 1</p>	

# Energy and data transmission

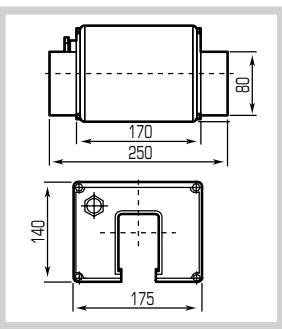
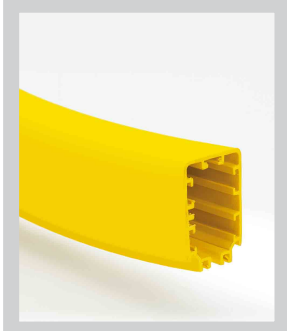
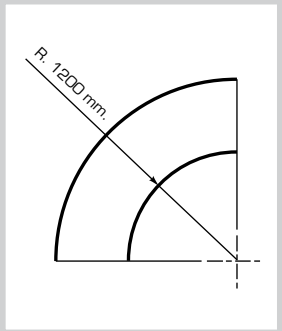
## TR85 Trolley Series

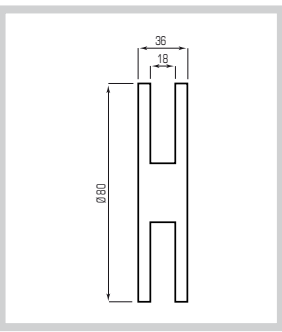
Conductor rails - Line B "continuous strip" type

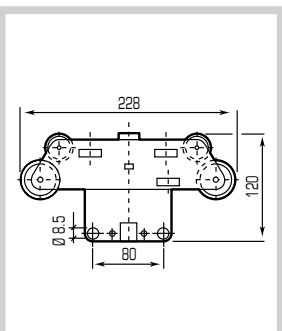
	DESCRIPTION	CODE	MIN. PACK QTY.	DIMENSIONS												
	<p><b>In line feed</b></p> <ul style="list-style-type: none"> <li>■ Cable entry with Pg 29 cable gland</li> </ul>	<p>TR8526</p>	<p>1</p>													
<b>CURVE 90° WITH 4 CONDUCTORS</b>																
	<p><b>Curve radius:</b></p> <table border="1" data-bbox="534 1025 847 1160"> <tr> <td></td> <td>R. 1200 mm</td> </tr> <tr> <td>(1)</td> <td>R. 1400 mm</td> </tr> <tr> <td>(1)</td> <td>R. 1800 mm</td> </tr> <tr> <td>(1)</td> <td>R. 2200 mm</td> </tr> </table> <p>The curve must be ordered together with the line. The wires are already calculated in the total length of the line.</p>		R. 1200 mm	(1)	R. 1400 mm	(1)	R. 1800 mm	(1)	R. 2200 mm	<p>70A... 140A</p> <table border="1" data-bbox="884 1025 1029 1160"> <tr> <td>TR8529A90</td> </tr> <tr> <td>TR8529B90</td> </tr> <tr> <td>TR8529C90</td> </tr> <tr> <td>TR8529D90</td> </tr> </table>	TR8529A90	TR8529B90	TR8529C90	TR8529D90	<p>1</p>	
	R. 1200 mm															
(1)	R. 1400 mm															
(1)	R. 1800 mm															
(1)	R. 2200 mm															
TR8529A90																
TR8529B90																
TR8529C90																
TR8529D90																
<p>(1) Curve composed by 2 pieces</p>																
<b>INSTALLATION ACCESSORIES</b>																
	<p><b>De-coil unit</b></p>	<p>TR8513</p>	<p>1</p>													
	<p><b>Strip insertion trolley</b></p>	<p>TR8514</p>	<p>1</p>													

# Energy and data transmission

## TR85 Trolley Series

Line A and B



TECHNO-LIFTING EQUIPMENT

### ACCESSORIES - SPARE PARTS



#### IP23 SEALING STRIPS

Protects and prevents accidental operation of the operator

- PVC Material
- Hardness Shore A 81
- Resistance to cold - 30 degrees
- Stretching 340%

For order, to consider twice the length of the line

**TR8505**

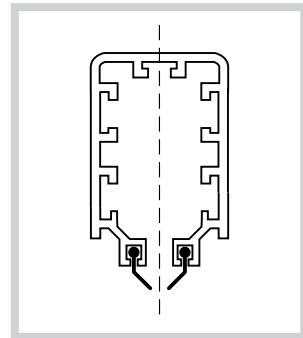

#### INSPECTION JOINT

With multiple trolleys allow easy maintenance or replacement of trolleys.

**TR8528**



#### COLLECTOR SHOES

35A Trolley

**TR8517**

70A Trolley

**TR8520**



#### FIXED POINT

Used to create a fixed point along the line as a starting point for the distribution of expansions.

**TR8527**

# Energy and data transmission

## CP Series conductors

Flat cables

### PVC FLAT CABLES ANTI-AGING H07VVH6-F

Particularly suitable for supply and control circuits, lifting and handling equipment.



- Comply with CEI 20 - 22 II (flame resistant)
- Insulation class 2/3
- Operational voltage 450/750V
- Sheathing colour blue
- Internal conductors with flexible PVC sheathing progressively numbered, plus earth conductor (yellow/green)
- Operating temperature -5 °C +70 °C

CODE	N° CROSS SECTION	APPROXIMATE OUTER DIMENSIONS	STRAND n./ mm	APPROXIMATE WEIGHT gr/m	TOTAL CROSS SECTION mm <sup>2</sup>	CODE	N° CROSS SECTION	APPROXIMATE OUTER DIMENSIONS	STRAND n./ mm	APPROXIMATE WEIGHT gr/m	TOTAL CROSS SECTION mm <sup>2</sup>
CP0415AF	4X1,5	15X5,2	30X0,25	150	6	CP2425AF	24X2,5*	54X13	50X0,25	1.100	60
CP0815AF	8X1,5	29X5,5		300	12	CP0404AF	4X4	21X7,5	56X0,30	330	16
CP1215AF	12X1,5	41X5		420	18	CP0804AF	8X4	38X5		550	32
CP1615AF	16X1,5	54X8		510	24	CP0406AF	4X6	24X8	84X0,30	440	24
CP1815AF	18X1,5	43X11		700	27	CP0806AF	8X6	38,5X8		742	48
CP2415AF	24X1,5	51X13		1.000	36	CP0410AF	4X10	35X11	7X12X0,40	800	40
CP0425AF	4X2,5	21X5,7		50X0,25	240	10	CP0416AF	4X16	36,5X12	7X18X0,40	1.200
CP0825AF	8X2,5	33X6	420		20	CP04250AF	4X25	43X13	7X28X0,40	1.700	100
CP1225AF	12X2,5	50X7	640		30	CP0435AF	4X35	50X14	7X39X0,40	2.050	140
CP1625AF	16X2,5	41X13	1.000		40						
CP1825AF	18X2,5*	50X13	1.050		45						

On request the same cables can be supplied - minimum requirement is 500 m - with: heat resistant upto 105° tinned red copper shield.

\* Minimum supply 500 m.



# Energy and data transmission

## CT Series conductors

Round cable with dual strain relief cords



TECHNO-LIFTING EQUIPMENT

### ROUND CABLE WITH DUAL STRAIN RELIEF STEEL WIRES - S05VVD7-F

Made for heavy duty applications in particular for pendant push button stations and moving electromechanical components. The two steel wire ropes are embedded, diametrically opposed to PVC sheathing. The rope cut into lengths and just hooked the steering control to avoid any stress on the cable.



- Comply with CEI 20 - 22 II (flame resistant)
- Insulation class 2/3
- Operational voltage 300/500V
- Sheathing colour blue
- Internal conductors with flexible PVC Sheathing progressively numbered, plus earth conductor (yellow/green)
- Operating temperature: -5°C +70°C
- Ø 2mm steel wires
- Breaking point: 60 kg/mm<sup>2</sup>

CODE	N° CROSS SECTION	APPROXIMATE OUTER CABLE Ø	DIMENSIONS WIRE ROPE	STRAND n./ mm	APPROXIMATE WEIGHT gr/m	TOTAL CROSS SECTION mm <sup>2</sup>
CT0815AUAF	8X1,5	11,6	23,6	30X0,25	225	12
CT1215AUAF	12X1,5	14,4	26,4		315	18
CT1615AUAF	16X1,5	16	28		415	24
CT1815AUAF	18X1,5	17	29		470	27
CT2015AUAF	20X1,5	18	30		525	30
CT2415AUAF	24X1,5	21	33		620	36

### FLAT CABLE

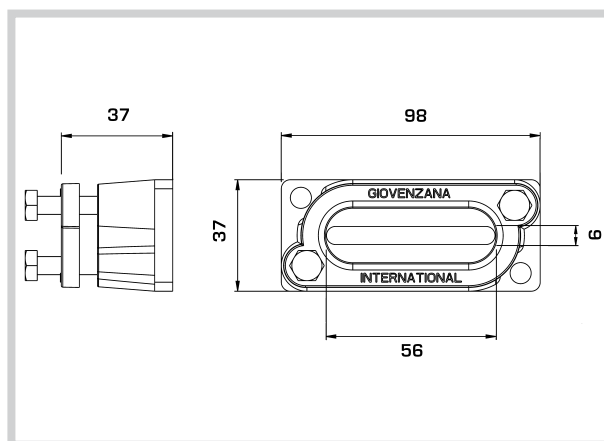

12903010

# Energy and data transmission

## Complementary products

### Switch - Disconnectors

#### BASE FIXING

- Comply with rules: IEC 947-3, EN60947-3, UL 508
- Fixing box DIN-RAIL 50022-35
- Terminal protection class IP20
- Complete of command to knob with locking (max.3 lck) with yellow front plate - red knob
- Protection class EN60529-IP65, UL50 Type 1 - 4 - 4x (\*)

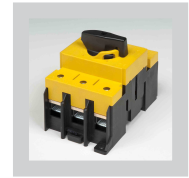
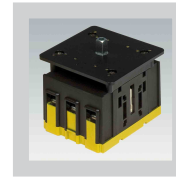

SERIES	AC-21A AMP.690V	AC-23A AMP.400V	SCHEME	CODE
SQ032	40	32	<p>3 POLES</p>	SQ032003B
SQ063	80	67		SQ063003B
SQ125	125	125		SQ125003B

#### DOOR INTERLOCK COMMAND



- Yellow front plate
- Red-knob
- Locking knob (Max3)
- 67

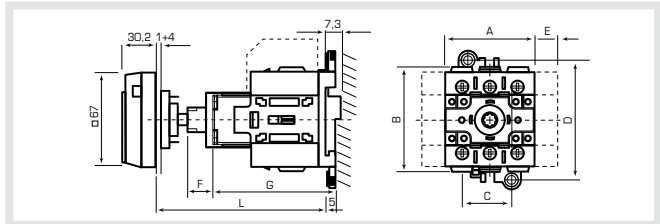

FOR SERIES	CODE	SERIES	A	B	C	D	E	F	G	L
SQ032	012/0001 *	SQ032	45	52,6	22	60	12,5	13,5	60,3	80...142 max
SQ063	042/0001 *	SQ063	52,5	72,5	43,5	82,5	17,5	23,5	67,8	112...142 max
SQ125	231/0001	SQ125	65,2	92	51,2	102,2	22,5	16	64	127...327 max

#### ELECTRICAL CHARACTERISTICS

CHARACTERISTICS IEC/EN60947-3			SQ032	SQ063	SQ125	
Rated insulation voltage Ui	V		690	690	800	
Rated impulse withstand voltage Uimp	kV		8	8	8	
Rated thermal current Ith-Ithe	A		40	80	125	
Frequency	Hz		50/60	50/60	50/60	
RATED OPERATING CURRENT Ie:						
AC-21A Switching resistive loads with light overloads	690V	A	40	80	125	
AC-22A Switching mixed resistive and inductive loads with light overloads	690V	A	32	80	25	
AC-23A Periodic switching of motors	3 phases - 3 poles	230V	A	32	75	125
		400/500V	A	32	67	125/100
		690V	A	20	32	80
Rated breaking capacity (cosφ 0,45)	400V	A	256	536	1000 (cosφ 0,35)	
Conditional rated short circuit		kA	10	10	10,5	
Fuse rating gG	690V	A	40	63	125	
Connectable section	flex cable	mm <sup>2</sup>	1,5-10	6-25	10-70	
	rigid cable	mm <sup>2</sup>	1,5-16	10-35	10-70	
		AWG	12-6	10-2	-	
General Use UL 508	600Vac	A	40	80	-	

- Performing basic 3 poles with mounting possibilities on three sets of power contacts, Neutral, ground and auxiliary contacts NC and NO.
- Certification cUL Series SQ032 - SQ063



## **GIOVENZANA INTERNATIONAL B.V.**

WTC - Strawinskylaan 1105, 1077 XX Amsterdam, The Netherlands  
Ph. +31(0)20.4413576 - Fax +31(0)20.4413456

G.M.K. K.f.t. - 1068 Budapest - Hungary - Rippl Ronai ut.13  
Ph. +36.37.572575 - Fax +36.37.572570 - e-mail: gmk@giovenzana.com

### **BRANCH**

**DUBAI** U.A.E. P.o. Box 262146 - J.A.F.Z.A.

Ph. +971.4.8870788 - Fax +971.4.8870787

**MOSCOW** Russian Federation - Lihov pereulok 8, kb 10

Ph. +7.495.6991296 - +7.495.6996444 - Fax +7.495.6505254

**[www.giovenzana.com](http://www.giovenzana.com)**